

shower channel CeraLine F Duo 1800 mm, BS 2"

Part number: 525055
 GTIN: 4001636525055
 Rebate group: 8

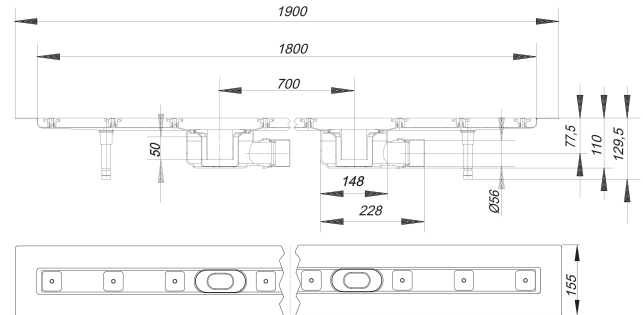

Description:

shower channel CeraLine F Duo 1800 mm, BS 2"
 conforming to DIN EN 1253

Linear drainage, with two drain bodies, outlet horizontal, ball-joint adjustable 0°–15°-degrees,
 DN 50, BS 2" sw socket or HDPE 56 mm

specification

- sound-insulated, height adjustable levelling legs
- integral sand coated flange for secure bonding of under-tile waterproofing
- removeable trap insert, 50 mm water seal (conforming to DIN EN 1253)
- height adjustable pedestals for levelling the cover-plate
- temporary blanking plate
- tiling gauges
- tile-trim jig

material

channel 304 stainless steel, trap polypropylene

Options for CeraLine F Duo:

Any made-to-measure length up to 2000 mm can be supplied. Please enquire!

The outlet connector can be supplied in ABS to suit British Standard sizes and PE-HD conforming to DIN EN 1519. Please enquire.